

ScanPal™ Mobile Computer Series

EDA60K-0 Quick Start Guide



EDA60K-SC-QS Rev A
DEC/26/2017

Please check to see if it contains the following items:

- ScanPal EDA60K Mobile Computer;
- Main battery (3.7V, lithium-ion battery);
- 10W battery adapter;
- Interchangeable adapter plug;
- USB power cable;
- Quick Start Guide.

Remarks:

If you ordered accessories for the terminal, please make sure they are also included in the package; be sure to keep the original packages for ScanPal™ EDA60K to be returned for repairing when necessary.

Disclaimer:

The manufacturer shall not be held responsible for any consequences arising from the user's failure to follow the above recommendations or erroneous use of the mobile phone. Our product's operating system supports updates in official system. If the user adopts a third-party ROM system or make any revisions to the operating system through for example jail breaking, the system may be rendered unstable, in which case our company will not Power indicator provide support to the user or bear any responsibility.

EDA60K belongs to ScanPal™ Series

Front Panel

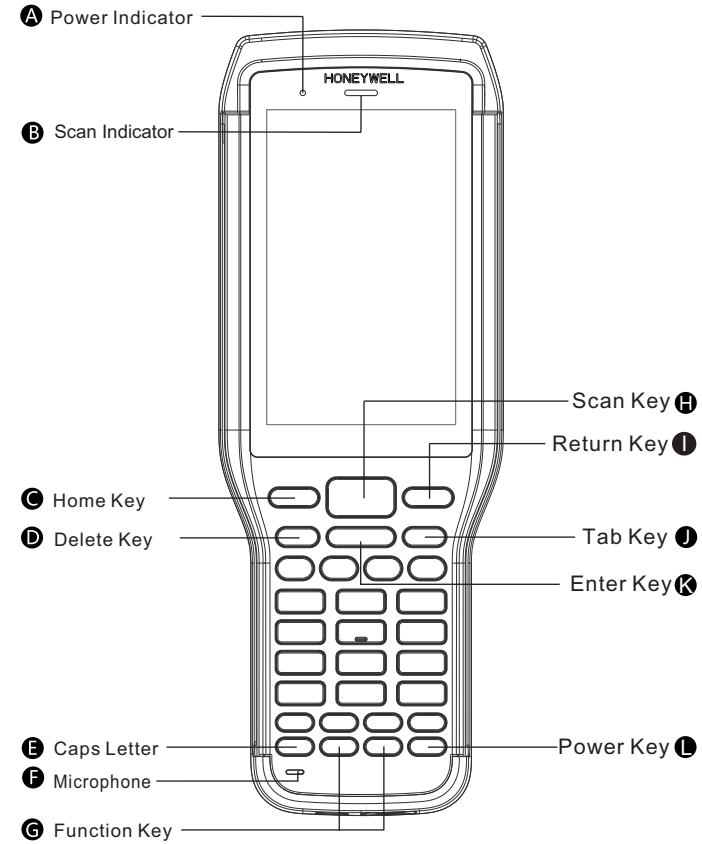

Rear Panel

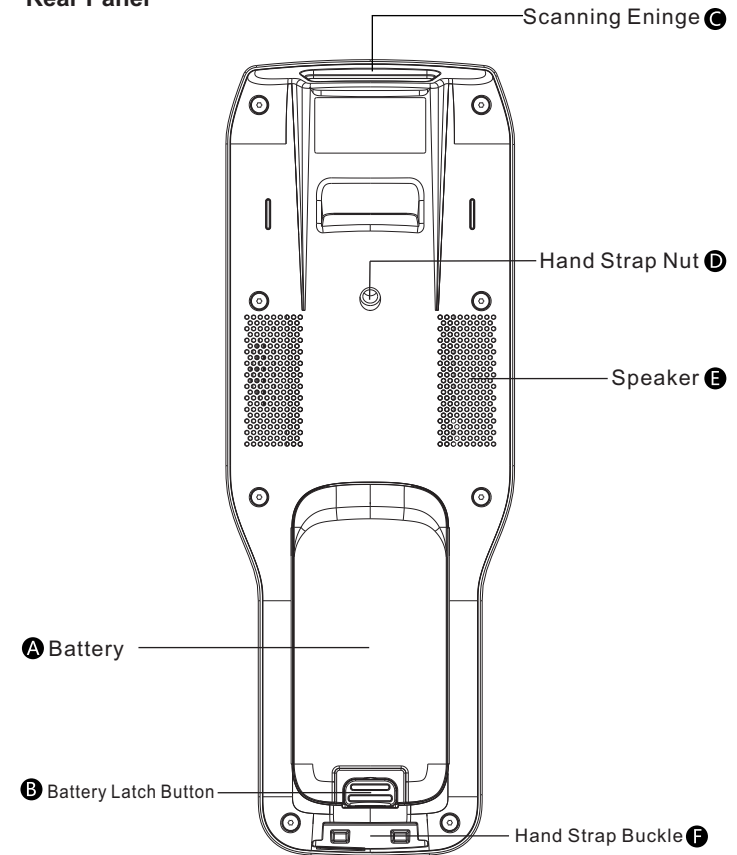

Left Side View

Right Side View

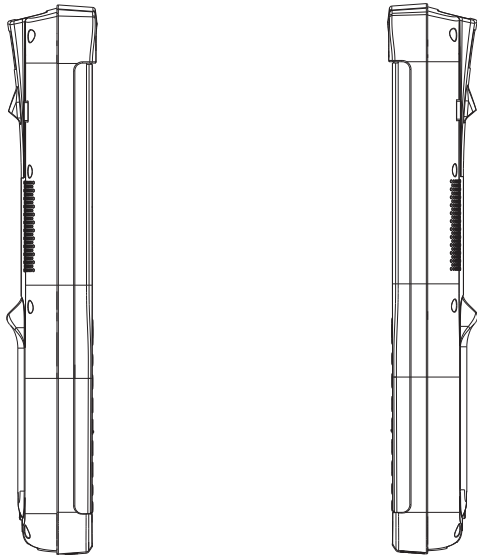

Bottom View

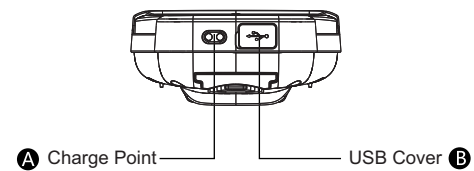

Install the Main Battery

Replace the battery with wrong models may cause explosion. Please make sure to use the battery in accordance with local regulations. Please recycle the battery when possible. Do not dispose it as household waste. Please ensure all kits are dry when connect the mobile device or battery to external devices. Damages caused by connecting wet kits are not covered by the warranty.

ScanPal™ EDA60K comes with a battery in a separate package. Please follow the steps below to install the battery.

1. Press down the battery lock button to unlock the battery;
2. Remove the battery as the arrow on the way;
3. Insert the battery (Insert the non-battery lock button side first in the direction of the arrow.)
4. Press down the back of battery in the direction of arrow, then the battery latch can be locked.

Remarks:

Refer to the illustrated installation steps on the following page.

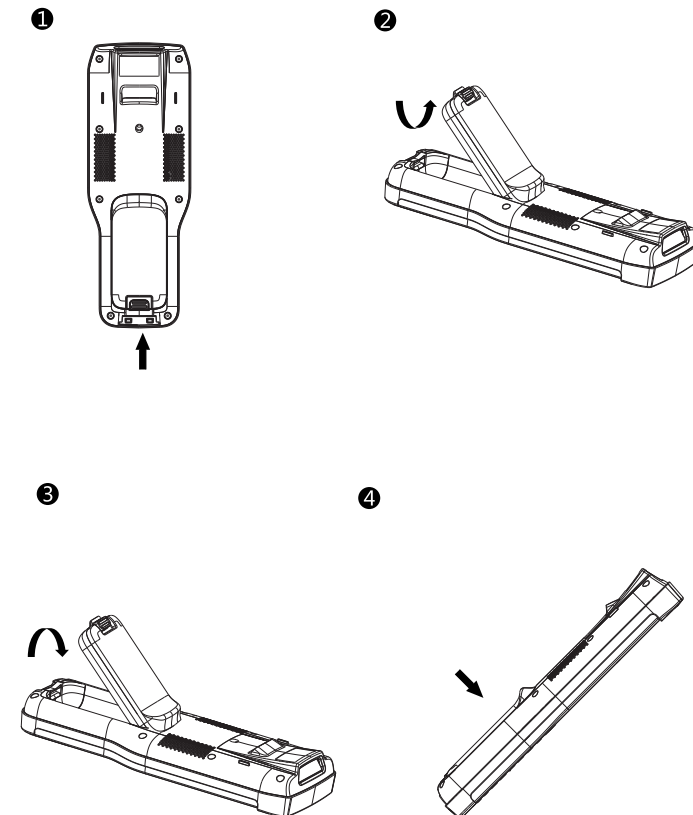

Charging / Sync

Synchronous Communication

Open the USB cover of EDA60K; Connect the EDA60K to the computer with USB cable.

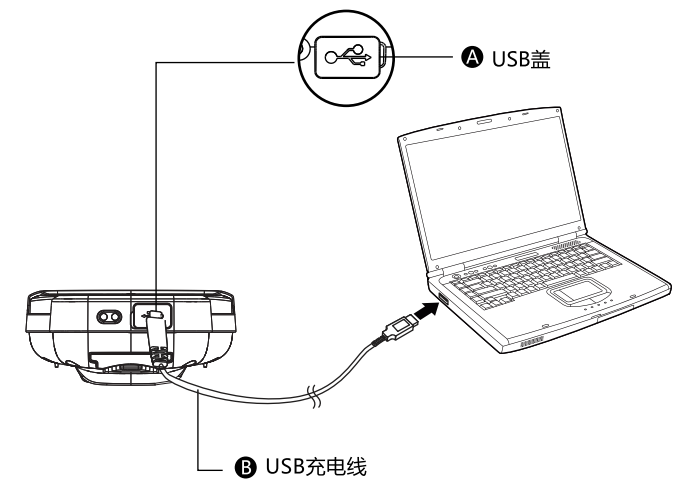

Charging / Sync

Charging

1. Open the USB cover of ScanPal™ EDA60K ;
2. Connect the ScanPal™ EDA60K to computer with USB cable ;
3. Make sure the replaceable adapter plug plugged into the power adapter;
4. Connect the power adapter to the wall plug and start charging for ScanPal™ EDA60K .

Get ScanPal™ EDA60K charged for at least 4 hours before using it, subject to your battery models.

Using the terminal while charging will significantly extend the time required for fully charged.

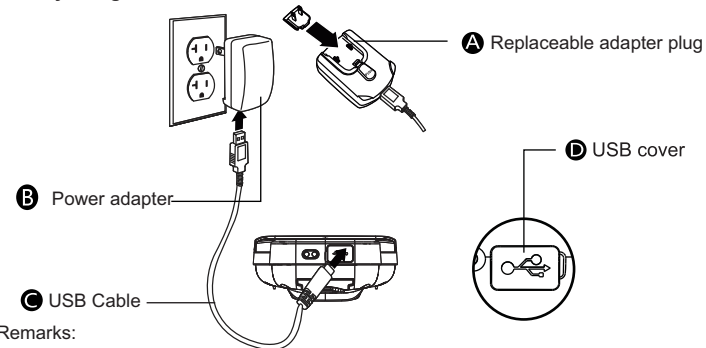

Remarks:

It's recommended to use Honeywell's peripherals, batteries, USB charging cables and power adapters.

Damages caused by using non-Honeywell peripherals, batteries, USB charging cables or power adapters are not covered by the warranty.

Warnings:

Please make sure all kits are dry when use the terminal and battery with other accessories.

Damages caused by using wet kits may not be covered by the warranty.

Aiming Beam

The aiming beam gets narrower when the terminal gets closer to the barcodes, while it gets wider when the terminal gets farther from the barcodes.

The smaller the barcodes, the closer the aiming beams should get to the barcodes
The bigger the barcodes, the father the aiming beams should get to the barcodes

Beam positions when scan 2D images



Suspend / Wake Up the Terminal

Suspend / Wake Up the Terminal

Press the power button and then release (less than 2 seconds)

To wake up the device from sleep mode, press the power button and then release (less than 2 seconds)

ScanPal™ EDA60K Power Indicator

The status of power indicators in non-charging and charging process are illustrated as below:

Non- charging process	
Off	Battery power is normal
Flashing orange	Battery power is low
Charging process	
Constant green	Charging complete
Flashing green	During charging process, and the charging is about to be completed
Orange	During charging process, and the battery power is still low
Flashing red	Battery is abnormal

Install Micro Sim Card

1. Power off;
2. Press down the battery latch button to remove the battery;
3. Slide the Sim Card cover and unlock the Sim card in the direction of arrow, then open the Sim Card cover;
4. Insert the Micro Sim Card to the card slot;
5. Reposition the card slot, then slide the card slot and lock the Sim Card;
6. Press down the back of battery then the battery can be locked;
7. Power on.

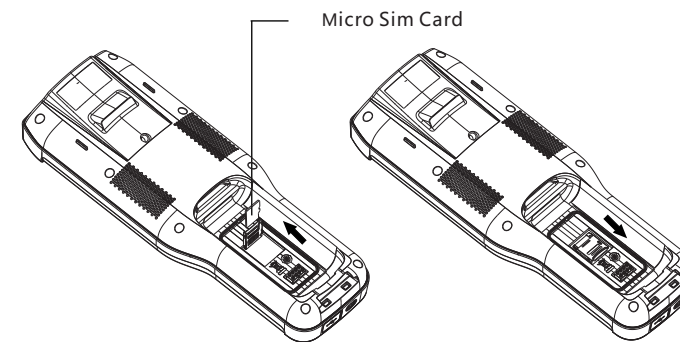

Use Scan Engine

Align the aiming beam with the barcodes, and adjust the angle between the beam and the barcodes to get the best results.

The best scan distance relate to scan engine model.

1. Click the demo application on the interface, and then select Scan demo program;
2. Click Scan on the screen or press the Scan Button;
3. Align ScanPal™ EDA60K with the barcodes;
4. Adjust the aiming beam: in order to obtain the best performance, avoid scanning in a slight angle and slowly move the beam on the barcodes by scanning the reflection of the barcodes;
5. The terminal will beep when the barcodes are successfully decoded, which means the information included in the barcode has been obtained by the terminal

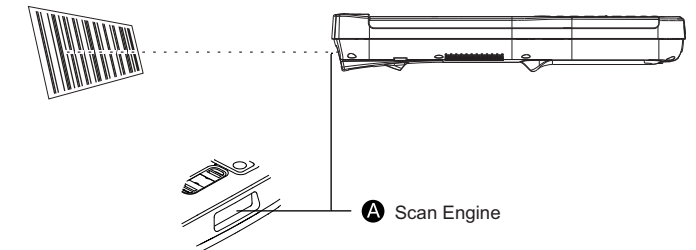

Technical Support

For information about technical support, after-sales service and maintenance, please visit www.honeywellaidc.com .

User Documents

For the local version of this article, please visit www.honeywellaidc.com .

Patents

For information on patents, please refer to www.honeywellaidc.com/patents.

Warranty

Please log into www.honeywellaidc.com/warranty_information for warranty information on your product.

Disclaimer

Honeywell International Inc. reserves the rights to modify the specifications and other information mentioned above without prior notification.

Readers should consult Honeywell International Inc. to make sure if any changes made any time they read this article.

The information in this article does not represent any commitments of Honeywell International Inc.

Honeywell International Inc. is not responsible for direct or indirect loss caused by any technical or editing errors or omissions contained in this article.

The proprietary information contained in this article is protected by copyright.

All rights reserved.

Without prior written consent from Honeywell International Inc., any form of photocopy, copy or translation into other languages for any part of this article is not allowed.

Honeywell

All Rights Reserved by Honeywell International Inc.
Website: www.honeywellaidc.com